

Equipment Built for the Fertilizer Industry



**WACKER
NEUSON**
all it takes!



The toughest materials. The highest demands. We've got it all handled.

When you're moving as much as 600 tons of fertilizer per day, you need a machine that can stand up to the toughest environment in agriculture. That's why, when we built our machines to move fertilizer, we asked operators in leading fertilizer houses about their biggest challenges. Then, we engineered our equipment to do more than they thought possible.

Corrosive materials: Fertilizer can shorten your equipment's life span, and that's costly. Our anti-corrosion topcoat option protects your investment.

Tight spaces: Narrow aisles, low bin heights and tall mixers and trucks mean you need equipment with versatility that includes a tight turning radius and compact dimensions, while providing more reach.

Avoiding spills: Spilled fertilizer is lost money. Our exclusive bucket design helps keep those fertilizer pellets in the bucket while in motion.





Work with the people who know fertilizer.

There's material handling for construction and then there's material handling for fertilizer. Wacker Neuson has specialists working directly with some of the largest retailers in the fertilizer industry and many dealers that focus only on equipment for agriculture applications.

Because we have people in the field, we understand the demands put on your machines. That means your Wacker Neuson dealer can give you years of expertise and solutions tailored to your needs, including:

- **Personal consulting:** Our Product Solution Specialists will work with you to select the machine and the options for your unique application and working environment.
- **Warranty, financing and leasing:** Many companies avoid offering warranties or leases when machines handle corrosive materials. Ask about our customized programs.
- **Customized training:** Even highly experienced equipment operators can benefit from the expert trainers at the Wacker Neuson Technical Academy.



Designed to move fertilizer, not dirt.

In the fertilizer house, you're moving something of value — spilled product wastes money and time. Buckets designed for construction applications just won't cut it. We worked with Bradco to build a bucket custom-designed to handle fertilizer efficiently. So you can move more, move it faster, and avoid costly waste.

Engineered to avoid spills: A higher back and an anti-spill lip prevents material loss during roll back, keeping fertilizer in the bucket until you're ready to unload.

A larger bucket, not a larger footprint: Our 1.45 yd³, 73" bucket is designed to maximize the load, so you can move more fertilizer, more efficiently.

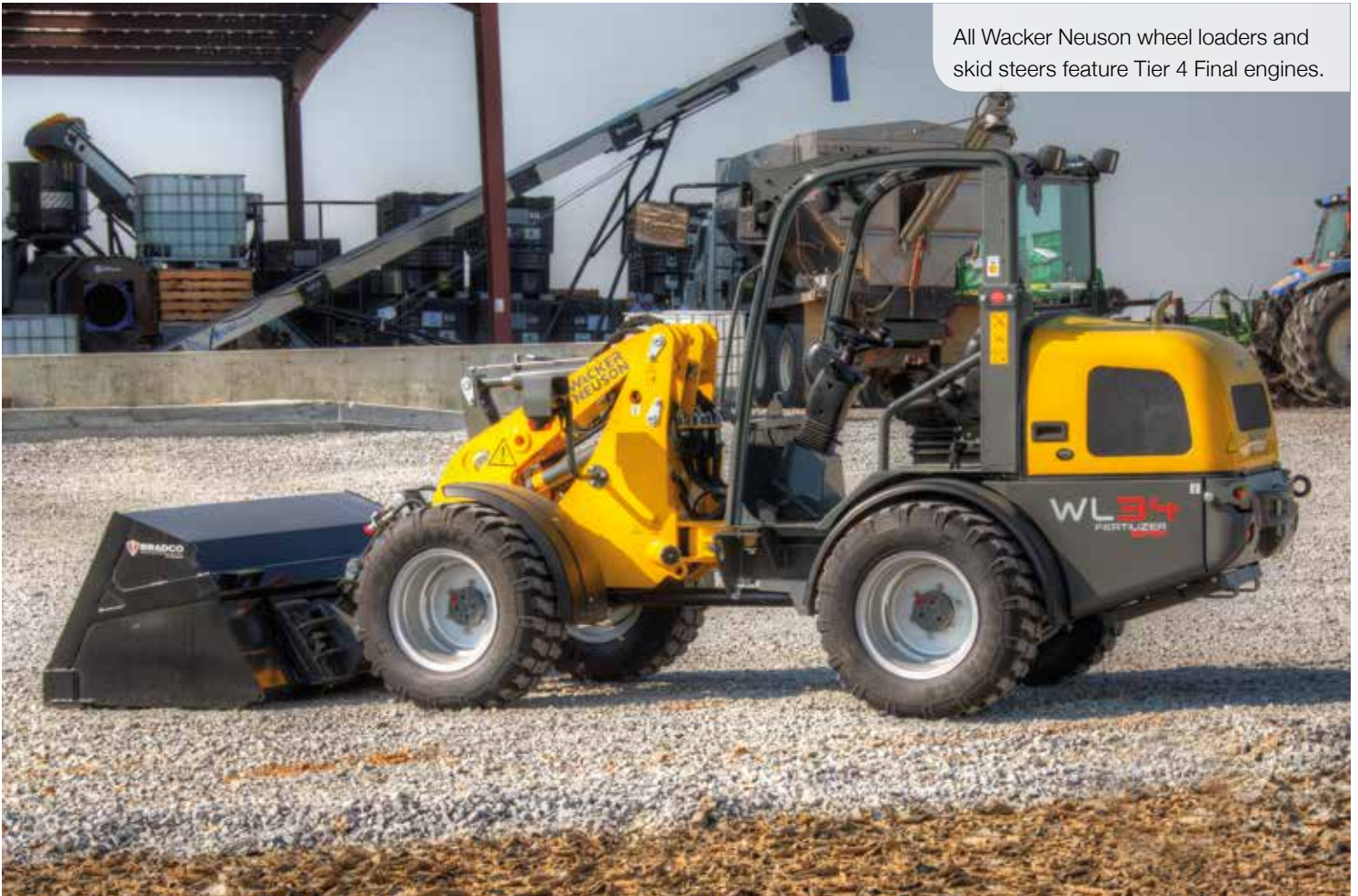

The story behind new emission requirements.

As part of the Clean Air Act, the U.S. Environmental Protection Agency (EPA) has adopted a comprehensive national program to reduce emissions (diesel particulate matter and nitrogen oxide) from off-road diesel engines. To meet these new emission standards, equipment manufacturers are using advanced engine and emission control technologies similar to those already used for highway diesel vehicles.



Protect your investment: Nyalic® anti-corrosion topcoat.

Fertilizer takes a toll on your equipment. Its corrosive properties destroy the finish and limit the life span of mechanical elements, hoses and connectors. That's why we recommend Nyalic coating. Applied to all mechanical, machine and hose areas, Nyalic provides a clear, glossy hard finish that seals treated areas to protect from moisture and corrosive chemicals.

Nyalic offers these benefits plus a limited three-year warranty:

- Helps prevent fertilizer dust from sticking to machine finish or components.
- Minimizes corrosion from harsh chemicals in fertilizer.
- Is not affected by UV rays.



Nyalic is an available option on all Wacker Neuson fertilizer models.

Wacker Neuson and the EPA's Clean Air Act.

At Wacker Neuson, we have always made it a priority to design and build equipment with the customer as well as the environment in mind. That's why every Wacker Neuson loader is built in compliance with the EPA's Clean Air Act and the stringent Tier 4 requirements for off-road diesel engines.

To meet these goals, we employ a variety of solutions depending on the type of machine, engine horsepower and its intended use. To meet Tier 4 Final requirements, our equipment incorporates exhaust after-treatment systems such as Diesel Particulate Filter (DPF), Particulate Matter Catalyst (PMC) and Diesel Oxidation Catalyst (DOC).



The SW28 Fertilizer Edition: the only skid steer of its kind.

Every detail has been engineered for the demands of moving fertilizer. And with the Nyalic anti-corrosion coating option, you can be more efficient today and for seasons to come.

Built to haul more: Eight counterweights increase your lift capacity by adding 380 pounds to the rear of the machine.



Operator comfort: The entire cab is ergonomically designed to maximize comfort and reduce operator fatigue, with wide entryways, flat floors, ample leg room and an integrated HVAC system.

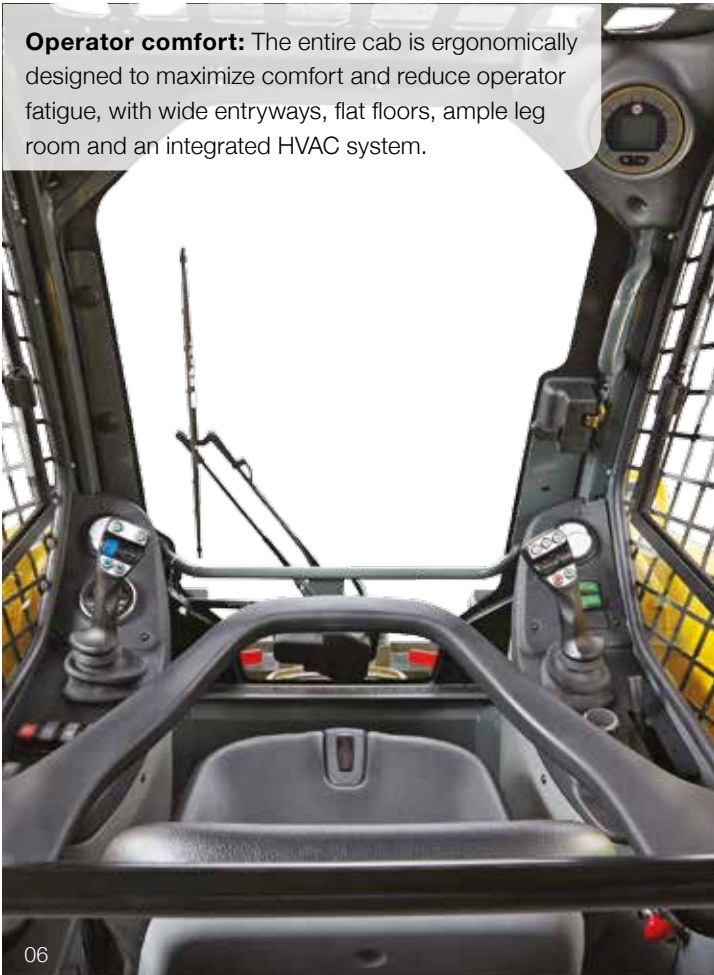

Unique bucket design: Reduces spillage without operator adjustments.

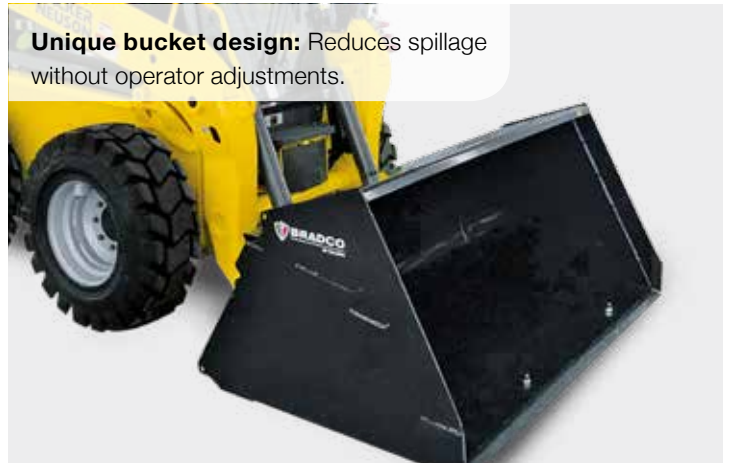

Severe-duty tires: Get speed, agility and durability with tires designed to withstand the toughest conditions.



Visibility and maneuverability: Cab-forward design with curved front glass gives the operator a better view, while the ISO pattern pilot-controlled joysticks offer smooth response and maximum control.



**Reaching higher.
Loading made easier.**

With an 11' 2" bucket hinge height and vertical lift, you get more reach at full height, ideal for dumping and loading trucks with high sides. That means loading hoppers and using pallet forks is easier and more efficient.



The WL34 Articulated Wheel Loader: the tightest turning radius available.

You work in tight spaces where every inch of maneuverability makes a difference in your efficiency. With the WL34, you get a tight 4-foot turning radius to minimize repositioning plus a rigid one-piece chassis for unbeatable stability under load.



Stability and flexibility: Reversible tire rims provide a 60:40 split for greater stability, as well as the option to flip the tires if the machine is operating in a smaller fertilizer house.

Articulation and oscillation:

Minimizes turning radius and increases maneuverability on both smooth and uneven terrain.

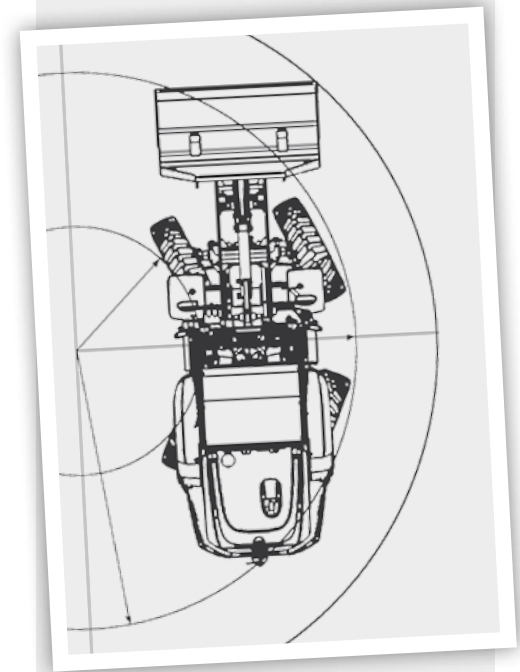

360-degree visibility: The window and cab design, plus a high central operator seat position, means there are no blind spots — no matter what position the bucket is in.

Power and durability: Heavy-duty planetary axles provide high torque, while the rugged cast metal counterweight improves lift capacity and protects the rear of the machine.



Corrosion resistant: Nylic anti-corrosion coating option helps minimize the corrosive effects of fertilizer.

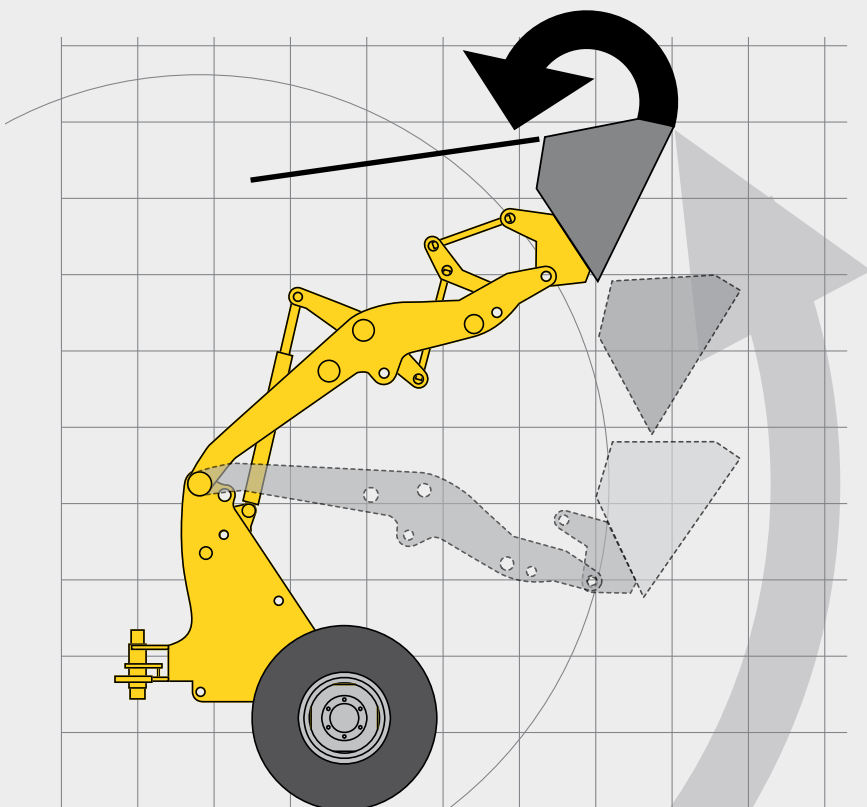

P-Z bar configuration:

Increases breakout forces and dumping speed to maximize cycle times, increasing efficiency.

1 Loading with a lot of power.

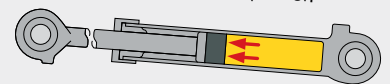

2 Unloading with high speed.

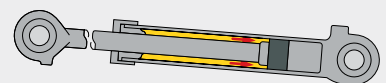

On the level:
avoid costly spills.

Our exclusive kinematic system uses brackets designed to continually roll the bucket back during lift. This keeps the bucket level as it moves up, to avoid spilled fertilizer.

Our full line of compact equipment for the fertilizer industry.

Seven machines. Infinite possibilities. Your Wacker Neuson dealer is ready to help you choose the options and attachments to make any of our machines the ideal solution for your fertilizer operation's needs.



Skid Steer Loader

SW28



Telescopic Wheel Loader

8085T



WL32



WL34



WL38

Articulated Wheel Loaders



WL52



WL60

Articulated Wheel Loaders

More than equipment.

Products are only as good as the service, technical support and training behind them. Wacker Neuson and our network of dealers provide everything you need to keep running at peak performance all season long.

Parts and Service

A breakdown during the fertilizer season can cost you time and money — there's no time to wait for parts or service. That's why all Wacker Neuson parts are available via our U.S. distribution center and are typically shipped within 24 hours of your order. You can count on getting the parts, service, maintenance and support you need, when you need them.

Technical Training and Support

Wacker Neuson Technical Academy has been meeting the training needs of contractors, mechanics and dealer salespeople for years. Training classes are held at our production facility in Menomonee Falls, Wisconsin, just minutes from Milwaukee. Or, if you have a specific training need, we can bring the experts to your location. From in-depth industry-focused operation tips and process training to maintenance, our trained professionals can create a tailor-made program for you.



Ask your Wacker Neuson dealer about our warranty and financing programs.

While some companies won't warranty equipment that operates in your tough conditions, we offer options to protect your investment.

Wacker Neuson's line of compact equipment features a factory-standard, 24-month/2,000-hour machine warranty.

Ask your dealer about our three-year extended service protection plan. Valid in the USA and Canada.

Flexible finance options: We offer financing and lease programs that help you get the most machine for your money.

- Low down payments
- Zero percent seasonal payment options
- Cash-back options

Experts in your field. That's the difference.



**WACKER
NEUSON**
all it takes!

You know what it takes to succeed in the agriculture industry. Long hours. Hard work. The right tools. And people as dedicated as you. At Wacker Neuson, we offer the machines and services to meet your demanding requirements and specific environment.

Here's why Wacker Neuson is a smart choice:

Equipment specifically engineered to handle fertilizer. Not a retrofit, not pretty close, but designed to move fertilizer and built to last in the toughest conditions.

Local, hands-on, expert advice. Our Product Solution Specialists know the demands of the fertilizer business. We'll visit your location so you get the right equipment for your application.

Absolute quality. Wacker Neuson stands for reliability. Every component, every machine, every attachment. This is solid equipment, built for serious duty every day.

We do our best every day to ensure your success — with the right equipment and people who understand the challenges you face every season. Ask your Wacker Neuson dealer. That's all it takes.



www.wackerneuson.com