

# Wheel dumpers



**WACKER  
NEUSON**  
*all it takes!*



# Material management: Wacker Neuson delivers, when and where you need it.

## 1. Take on a variety of challenges – and easily master them.

You may not be able to choose the terrain, but you can choose your material handling machine. Even on the most difficult of ground conditions, Wacker Neuson's wheel dumpers can carry out any task. The articulated pivot point provides high off-road capability and excellent traction.

## 2. Performance-driven – simplifying tasks and machine operation.

Technologies need to prove themselves on the job site, every single day. Wacker Neuson wheel dumpers are equipped with high-quality hydrostatic drive systems, which provide reliable performance and will impress you with their user-friendly operation for many years to come.

## 3. Flexibility and reliability – the hallmark of our wheel dumper line.

Quality manufactured for durability and dependability with a range of standard features, Wacker Neuson wheel dumpers also offer a variety of configuration options. Choose the skip, tire and operator function options that are ideal for your needs, as you move from one type of project to another. Our contracted dealer network can assist you in selecting the right machine and configuration that will ensure powerful, reliable performance for the material handling tasks you tackle.

### Wacker Neuson – all it takes!

We offer products and services that meet your most demanding requirements and diverse applications. We are committed to reliability across our product line and we do our best every day to ensure your success. This is our passion and our promise.

## Wheel dumper model overview.



# Material transport that delivers every detail.

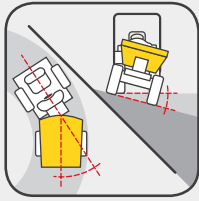

**Travel effortlessly over any terrain**  
Narrow passages and uneven surfaces are no match for a Wacker Neuson wheel dumper. The articulated pivot point allows them to access areas on a job site that other material movers simply cannot go.

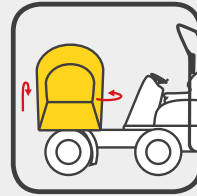

**Swivel skip**  
Maximizing flexibility for various tasks and job site conditions, Wacker Neuson wheel dumpers feature a skip that allows you to unload material on either side of the unit.



**Drive without shifting gears**  
The hydrostatic drive system makes driving simple and makes shifting unnecessary in many cases. With a single pedal, everything is under control.



**Cab or roll over protective structure (ROPS)**  
Operator safety and comfort are always a priority at Wacker Neuson. For our wheel dumpers, you can choose between a roll over protective structure (ROPS) and practical sun visor or a cab model with integrated heating and optional air conditioning.



**TELEMATICS**

**Real time machine status**  
With telematics, it's easy to not only locate your machines, but also check metrics like usage, operating time and machine condition.

## Operator safety features

The highest reliability combined with maximum comfort: The wheel dumpers from Wacker Neuson meet all safety standards and offer numerous features that make the work comfortable.



**All cabs satisfy Falling Object Protection Structure (FOPS) Level II** and are also available with front guard.



**Rotating beacon** for better machine visibility by others on the job site.



**Two forward-facing headlights** and one reverse-facing headlight, and complete road lighting for optimal visibility.



**With the front view camera** and an on-board screen on the DW90 and DW60, the operator has a view of the blind spot at the front of the machine.



**Reverse alarm** provides an acoustic signal when the machine is in reverse.

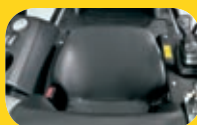

**A seat contact switch** only allows the machine to start up when the operator is seated. If the operator stands, the speed is reduced in a controlled manner. This promotes greater safety on the job site.



## Skips

Whether used on a construction site or in a cemetery, landscaping or municipal use, swivel skips are designed for different tasks, as conditions and applications demand.



### Swivel skip

The swivel skip puts your material exactly where you want it and is ideal for limited spaces.





## Hydrostatic all-wheel drive

**Giving the operator the freedom to hop on and concentrate on the task at hand, the hydrostatic all-wheel drive on Wacker Neuson wheel dumpers eliminates frequent gear shifting. This makes it ideal for rental applications or other situations where there may be high operator turnover.**

- Very easy to use because there are no frequent gear shifts
- Constant tractive force means no loss of traction when accelerating from 0 to maximum speed
- Controlled delay of the hydrostatic drive system eases the change between forward and reverse travel
- Hydrostatic braking effect as soon as the foot is removed from the gas pedal
- Wear-resistant drive system for low service and maintenance costs

**The central hydraulic motor drives both axles.**



**Permanent contact with the ground, even when tilted.**



## Articulated pivot point

**In many applications, rough terrain that includes bumps, small slopes and narrow access points are daily challenges. For this reason, all Wacker Neuson wheel dumpers are designed with an articulated pivot point. This ensures:**

- Excellent off-road capability, even under load
- Articulated pivot point steering up to max. 37°/15°, depending on the model
- Great ground contact and excellent traction

# Operator control platform

Wacker Neuson incorporates an innovative concept that puts operator efficiency and comfort at the forefront. Controls such as switches, the joystick and the display are placed on the right-hand side. This allows the left hand to remain on the steering wheel. Seating provides great visibility to the skip and the work area during transport and material placement.

- Joystick for safe and convenient operation
- Vandalism protection for increased service life of the components
- Display with service indicator for better maintenance planning
- Front view camera, rear view mirror, and optimal lighting for excellent visibility



**The lockable control compartment** helps prevent vandalism of the controls and the display screen.

**Do more with one hand:** the multi-function joystick handles dump operation, gear shift, change of travel direction, and ECO mode.



**Extremely simple operation:** inch-brake pedal on the left, gas pedal on the right.



# The right tires for your applications

In addition to the standard profile tires that provide good traction and a smooth, quiet ride, some Wacker Neuson wheel dumpers offer the option of turf tires that exert less ground pressure. These are ideal for landscaped areas, including golf courses and cemeteries.



**All-terrain profile**  
Standard tires for maximum traction.



**Turf profile**  
Large contact surface protects the ground.



# Cab

Good weather or bad, rough terrain or smooth, Wacker Neuson wheel dumpers have all it takes to ensure operator comfort and productivity, all year long. The enclosed cab environment features:

- Plenty of head and legroom
- Optimum all-round visibility for safe and efficient work
- ROPS/FOPS Level II certified
- Standard heat and air conditioning system (DW60 and DW90 cab models)



## Long service life

**With Wacker Neuson, you are choosing machines that will provide years of reliable, productive service. In addition to the high level of quality maintained throughout our manufacturing process, Wacker Neuson wheel dumpers are engineered for use in all kinds of conditions with:**

- A sturdy base that ensures durability, day-in and day-out
- The reliability of a hydrostatic all-wheel drive system
- Components from well-respected global manufacturers
- Exceptional base materials in every part of the machine
- A minimal number of wear parts to reduce maintenance and downtime



**DW60-DW90 standard air conditioning** provides the perfect working temperature with optimal air circulation.



**Ideal for transport:** foldable Roll Over Protective Structure (ROPS).



# Wheel Dumpers – material movers of choice.

Designed to save time and money, Wacker Neuson wheel dumpers function like a compact dump truck, but with all-terrain traction and better maneuverability. These versatile, articulated machines feature dumping from the front or the skip can be rotated 90 degrees in both directions to dump from either side. With payload capacities ranging from 6,614 lbs to 19,842 lbs, and heaped capacities ranging from 1.73 yd<sup>3</sup> to 5.75 yd<sup>3</sup>, these units feature a hydrostatic twin-lock all-wheel steer drive, providing optimum performance even in difficult and varying terrain. Cab versions are available on some models (excluding 3001 Concrete Edition and DW50). Ideal applications include:

- Landscaping
- Golf course construction, maintenance and restoration
- Cemetery tasks
- Trail and path construction and maintenance
- Construction material movement
- Concrete placement







# 3001

Designed for use indoors and out, the Wacker Neuson 3001 wheel dumper makes it extremely simple to navigate through narrow openings and pathways, even when carrying a large volume of material. You can move more, place it where it needs to be and increase your job site efficiency.

- Low-maintenance hydrostatic all-wheel drive
- Excellent off-road capability thanks to large ground clearance, articulated steering (37°) and oscillating angle (15°)
- Speeds of up to 13.7 mph promote faster task completion
- Enter and exit control platform from either side
- Concrete Edition with concrete chute
  - Place concrete precisely in remote sites
  - Transport more concrete faster
  - Maneuver in confined areas
  - Reduced splattering when placing

	3001	3001 CONCRETE
Max. payload	6,614 lbs	6,614 lbs
Engine output	36.2 hp	36.2 hp
Width	70.3 in	70.3 in
Skip capacity heaped	2.34 yd <sup>3</sup>	2.59 yd <sup>3</sup>



Concrete Edition



**Maximum safety** and operational strength in any weather, thanks to the optional cab.

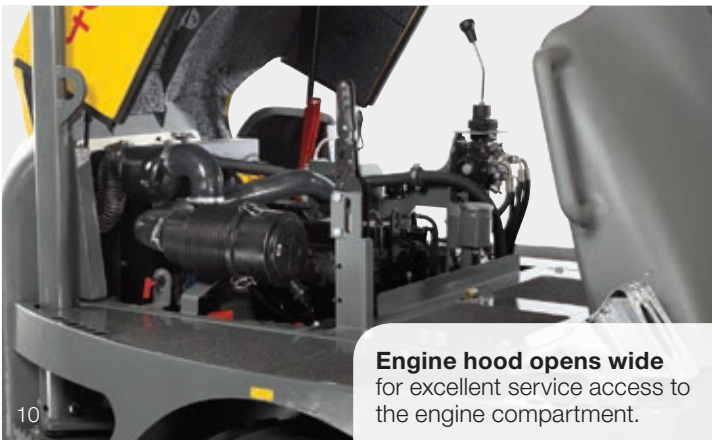

**Engine hood opens wide** for excellent service access to the engine compartment.



**Reliable and safe,** even under extreme conditions.

# DW50

The Wacker Neuson DW50 wheel dumper combines a compact design with powerful engine and hydrostatic all-wheel drive making it capable of hauling more in less time, reducing cycle times and increasing efficiency. Its exceptional versatility and capacity make it ideal for moving all types of material on any job site. The unique compact design, along with the powerful 74.2 hp engine, allows the DW50 to access confined areas, while providing the power needed to move heavier loads.

- High efficiency output thanks to the turbo diesel engine
- Easy, intuitive operation
- Hydrostatic drive allows for full traction power from 0 to max speed
- Maintenance-free DEC Deutz engine
- Large rear ramp angle and high ground clearance – ideal in uneven ground conditions
- Wear-free spring-loaded parking brake for a high level of reliability and durability

	DW50
Max. payload	11,023 lbs
Engine output	74.2 hp
Width	75.4 in
Skip capacity heaped	3.47 yd <sup>3</sup>

Combines the technology of the 6- to 9-ton class with the compact dimensions of the 3- to 5-ton class.



optional



The optimized design of the swivel tip skip keeps the working area perfectly in view.



The DW50 promotes operator comfort and efficiency with an open and intuitive control placement.

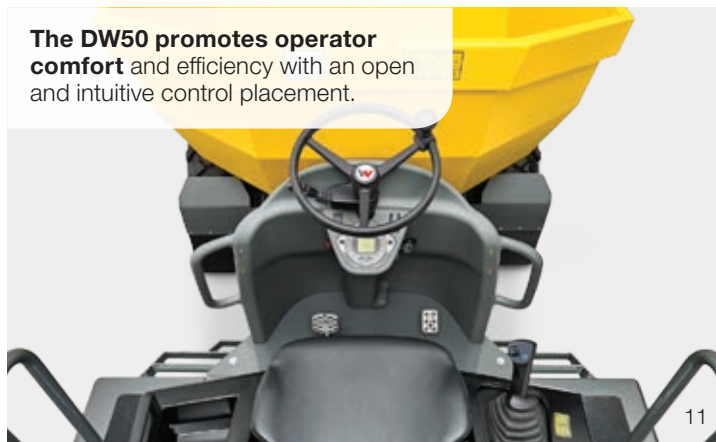

# DW60

Wacker Neuson wheel dumpers help you get material from one place to another and place it where it needs to be, even in difficult ground conditions. These heavyweights make light work of high volumes consistently, with great performance. Long maintenance intervals of 500 operating hours help maintain low operating costs. Front view camera facilitates accurate material placement.

- Low-maintenance hydrostatic all-wheel drive with the ECO Mode
- Skip versions can dump on all sides
- Air conditioning is standard on cab models
- Completely wear-free operation of the spring-loaded parking brake for durability and reliability
- Optional turf tires for use on existing or manicured landscapes

	DW60
Max. payload	13,228 lbs
Engine output	73.8 hp
Width	87.8 in
Skip capacity heaped	4.19 yd <sup>3</sup>



**All-wheel drive**  
with ECO mode.

**Lateral maintenance cover** is comfortably accessible from the ground for convenient service and increased safety.

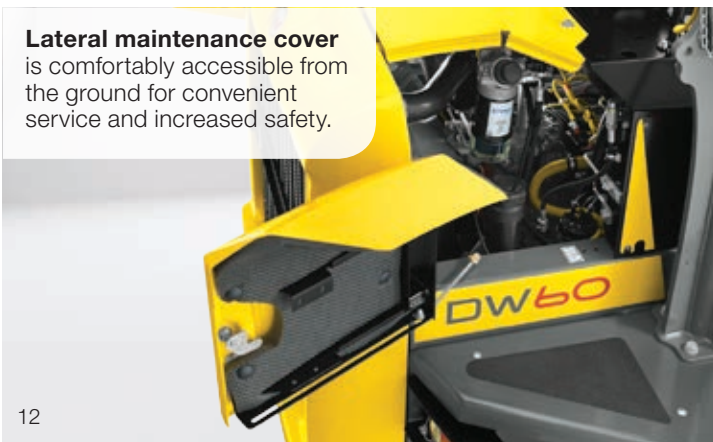

**Impressive in every situation,** thanks to high ground clearance.



# DW90

A versatile bulk material mover, the Wacker Neuson DW90 wheel dumper features articulated hydrostatic all-wheel drive designed to carry full payloads across rough terrain, muddy conditions and steep hills. Dumpers have a smaller footprint than traditional dump trucks and can easily maneuver around confined and busy job sites, moving dirt, aggregate and other substances faster, significantly improving cycle times.

- Low-maintenance hydrostatic all-wheel drive with the ECO Mode
- Swivel tip skip
- Air conditioning is standard on cab models
- Completely wear-free operation of the spring-loaded parking brake for absolute durability and reliability
- Front view camera promotes material placement and operational safety

	DW90
Max. payload	19,842 lbs
Engine output	73.8 hp
Width	97 in
Skip capacity heaped	5.75 yd <sup>3</sup>



### Versatile design

easily transports bulky material across rough terrain.



optional

**A gas pressure shock absorber** improves safety when folding down the Roll Over Protective Structure (ROPS) for storage or site accessibility.



**The robust and practical design** of the rear of the DW90 includes retractable taillights.



# Dimensions

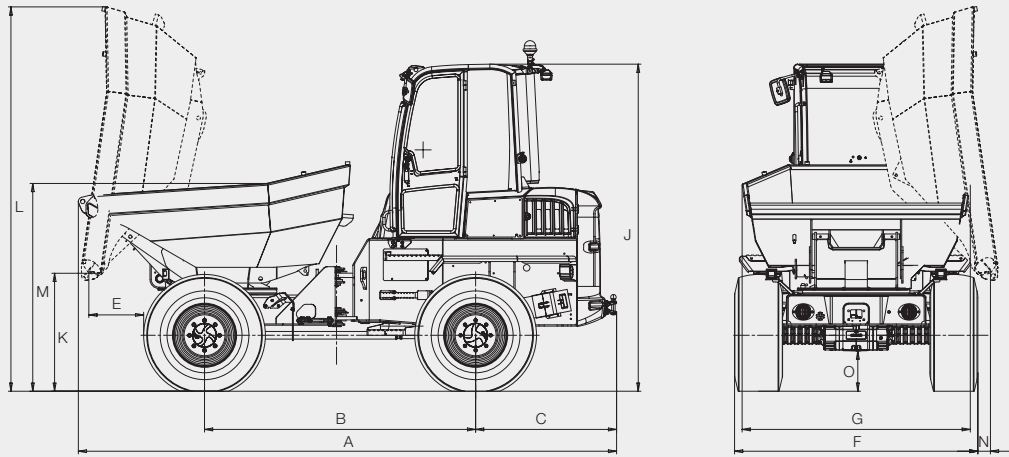

WHEEL DUMPER			3001	3001	DW50	DW60	DW90
			Swivel tip skip	Concrete edition	Swivel tip skip	Swivel tip skip	Swivel tip skip
GENERAL		UNIT					
A	Overall length	in (mm)	166.9 (4,240)	181.1 (4,600)	177.0 (4,495)	194.3 (4,934)	204.1 (5,185)
B	Wheel base	in (mm)	77.2 (1,960)	77.2 (1,960)	84.3 (2,140)	97.8 (2,485)	106.3 (2,700)
C	Rear overhang including tow-bar	in (mm)	49.6 (1,260)	49.2 (1,250)	48.4 (1,230)	46.9 (1,192)	50.9 (1,292)
E	Tipping distance	in (mm)	23.6 (600)	–	24.8 (630)	19.9 (1,505)	19.0 (482)
F	Width of vehicle	in (mm)	70.3 (1,785)	70.3 (1,785)	75.4 (1,915)	87.8 (2,230)	97.0 (2,463)
G	Width of bucket	in (mm)	69.9 (1,775)	70.1 (1,780)	75.2 (1,910)	82.3 (2,091)	89.5 (2,273)
H	Overall height of ROPS	in (mm)	105.1 (2,670)	108.3 (2,750)	110.8 (2,815)	122.4 (3,108)	132.0 (3,353)
I	Height ROPS folded down	in (mm)	73.6 (1,870)	77.0 (1,955)	79.9 (2,030)	86.1 (2,187)	100.2 (2,544)
J	Height of cab	in (mm)	102.8 (2,610)	–	–	117.8 (2,993)	127.7 (3,243)
K	Height of tipping edge Bucket tipped	in (mm)	40.2 (1,020)	15 (380)	45.7 (1,160)	46.2 (1,174)	46.0 (1,169)
L	Height of bucket tipped	in (mm)	123.0 (3,125)	120.9 (3,070)	142.5 (3,620)	138.7 (3,524)	152.2 (3,867)
M	Height of bucket not tipped	in (mm)	58.1 (1,475)	65.4 (1,660)	70.5 (1,790)	75.0 (1,905)	83.5 (2,121)
N	Tipping width lateral	in (mm)	9.6 (245)	–	10.2 (260)	4.0 (101)	7.4 (188)
O	Ground clearance	in (mm)	11.0 (280)	11.0 (280)	14.6 (370)	14.5 (369)	16.0 (406)

WHEEL DUMPER CONFIGURATION OPTIONS			3001	3001	DW50	DW60	DW90
			Swivel tip skip	Concrete edition	Swivel tip skip	Swivel tip skip	Swivel tip skip
BUCKET							
	Swivel tip bucket		●	●	●	●	●
	Special concrete bucket		–	●	–	–	–
OPERATOR STATION							
	ROPS		●	●	●	●	●
	Cab with heating		○	–	–	–	–
	Cab with HVAC		–	–	–	○	○
	Awning kit		○	○	●	●	●
TIRES							
	All-terrain		●	●	●	●	●
	Turf		○	○	○	○	–
MISCELLANEOUS							
	Tow-bar		●	●	●	○	○
	Road Lights		–	–	–	●	●
	Wheel chock		○	○	○	○	○
SECURITY							
	Front and rear work lights		○	○	–	○	○
	Side mirror		○	○	○	○	○
	Back-up alarm		●	●	●	●	●
	Flashing beacon		●	●	●	●	●
	Front view camera		–	–	–	●	●
	Seat contact switch		–	–	●	●	●

● Standard ○ Option – not suitable

# Technical data

WHEEL DUMPER

		3001 Swivel tip skip	3001 Concrete edition	DW50 Swivel tip skip	DW60 Swivel tip skip	DW90 Swivel tip skip
GENERAL		UNIT				
<b>Payload</b>	<b>lbs (kg)</b>	6,614 (3,000)	6,614 (3,000)	11,023 (5,000)	13,228 (6,000)	19,842 (9,000)
<b>Shipping weight</b> ROPS	<b>lbs (kg)</b>	5,622 (2,550)	5,842 (2,650)	7,595 (3,445)	10,728 (4,866)	12,486.85 (5,611)
<b>Bucket capacity</b> leveled	<b>yd<sup>3</sup> (m<sup>3</sup>)</b>	1.73 (1.32)	2.11 (1.61)	2.58 (1.97)	3.07 (2.35)	4.32 (3.3)
<b>Bucket capacity</b> heaped	<b>yd<sup>3</sup> (m<sup>3</sup>)</b>	2.34 (1.79)	2.59 (1.98)	3.47 (2.65)	4.19 (3.2)	5.75 (4.4)
<b>Bucket capacity</b> water volume	<b>yd<sup>3</sup> (m<sup>3</sup>)</b>	1.22 (0.93)	1.48 (1.13)	1.67 (1.28)	2.17 (1.66)	2.69 (2.06)
ENGINE		UNIT				
<b>Manufacturer/model</b>	–	Perkins 403F-15T	Perkins 403F-15T	Deutz TCD 2.9	Perkins 854F	Perkins 854F
<b>Type</b>	–	Tier 4 Final, water cooled 3-cylinder diesel	Tier 4 Final, water cooled 3-cylinder diesel	Water-cooled 4-cylinder turbo-diesel	Water-cooled 4-cylinder turbo diesel including intercooler	Water-cooled 4-cylinder turbo-diesel
<b>Power</b>	<b>hp (kW)</b>	36.2 (27)	36.2 (27)	74.2 (55.4)	73.8 (55)	73.8 (55)
<b>Displacement</b>	<b>in<sup>3</sup></b>	91.3 (1,496)	91.3 (1,496)	178.4 (2,925)	207.4 (3,400)	207.4 (3,400)
<b>Operating speed</b>	<b>rpm</b>	2,800	2,800	2,300	2,200	2,200
DRIVE CHARACTERISTICS		UNIT				
<b>Max. speed</b>	<b>mph (kph)</b>	13.7 (22)	13.7 (22)	17.4 (28)	15.5 (25)	15.5 (30)
<b>Articulation</b>	<b>degrees</b>	±37°	±37°	±37°	±29°	±29°
<b>Oscillation</b>	<b>degrees</b>	±15°	±15°	±15°	±11°	±11°
<b>Turning radius, external</b>	<b>in (mm)</b>	151.6 (3,850)	151.6 (3,850)	167.3 (4,250)	236.2 (6,000)	257.9 (6,550)
<b>Gradeability</b> max.	<b>%</b>	50	50	50	50	50
DRIVE SYSTEM		UNIT				
<b>Drive system</b>	–	Hydrostatic transmission, permanent 4-wheel drive, electronic driving direction switch		4WD Hydrostatic including ECO mode	4WD Hydrostatic including ECO mode	
<b>Tires</b>	–	11.50 / 80 x 15.3, 10PR	11.50 / 80 x 15.3, 10PR	12.5 x 18-16, 12PR	405 / 70-20 14PR	500/60 – 22.5 tractor tread
HYDRAULIC SYSTEM		UNIT				
<b>Drive pump</b>	–	Axial piston pump				
<b>Discharge volume</b>	<b>gal (l)/min</b>	33.3 (126)	33.3 (126)	34.3 (132)	40.2 (152)	45.2 (171)
<b>Operating pressure</b>	<b>psi (bar)</b>	5,221 (360)	5,221 (360)	6,527 (450)	6,527(450)	6,527 (450)
<b>Work pump</b>	–	Gear pump				
<b>Discharge volume</b>	<b>gal (l)/min</b>	12.0 (45)	12.0 (45)	12.0 (45)	18.0 (68)	18.0 (68)
<b>Operating pressure</b>	<b>(bar)</b>	3,191 (220)	3,191 (220)	3,191 (220)	3,481 (240)	3,408 (235)
TANK CAPACITY		UNIT				
<b>Fuel tank</b>	<b>gal (l)</b>	11.9 (45)	11.9 (45)	13.2 (50)	21.9 (83)	21.9 (83)
<b>Hydraulic oil tank</b>	<b>gal (l)</b>	8.7 (33)	8.7 (33)	10.5 (40)	14.5 (55)	14.5 (55)
NOISE EMISSIONS		UNIT				
<b>Sound power level (L<sub>WA</sub>)</b> (according to 2000/14/EC)	<b>dB(A)</b>	101	101	101	101	102



3001



3001  
CONCRETE



DW50



DW60



DW90

## Added value.

Warranty • Finance • Parts Availability



**WACKER  
NEUSON**  
*all it takes!*

Products are only as good as the service, technical support and training behind them. Wacker Neuson and our network of dealers provide everything you need to keep running at peak performance.



**2-YEAR  
WARRANTY**

**Warranty:** Wacker Neuson's line of compact equipment features a factory standard 24-month/2,000 hour machine warranty. Ask your dealer about our extended service protection plan. Valid in USA and Canada.



**GENUINE  
PARTS**

**Parts and Service:** A breakdown can cost you time and money. That's why all Wacker Neuson parts are available via our U.S. distribution center and are typically shipped within 24 hours of your order. You can count on getting the parts, service, maintenance and support you need, when you need them.



**ACADEMY**

**Technical Training and Support:** Wacker Neuson Technical Academy meets the training needs of contractors, mechanics and dealer sales people for years. Training classes are held at our production facility in Menomonee Falls, Wisconsin, just minutes from Milwaukee. Or, if you have a specific training need, we can bring the experts to your location. From in-depth industry-focused operation tips and process training to maintenance, our trained professionals can create a tailor-made program for you.



**FINANCE**

**Flexible Financing:**

- Low down payments
- Competitive rates
- Cash back options
- Seasonal payment options

Wacker Neuson is a global equipment manufacturer for the construction, agriculture, oil and gas, landscape, utilities and municipal industries. Our comprehensive portfolio stands firmly on outstanding reliability, innovative technology, personal service and close customer contact. In the United States and Canada, Wacker Neuson's full line of products are sold and rented by a network of over 4,000 dealers and supported by an industry leading team of factory trained sales, application and service personnel.

[www.wackerneuson.com](http://www.wackerneuson.com)